

XTREME SERIES Humidifier XS

User

Manual

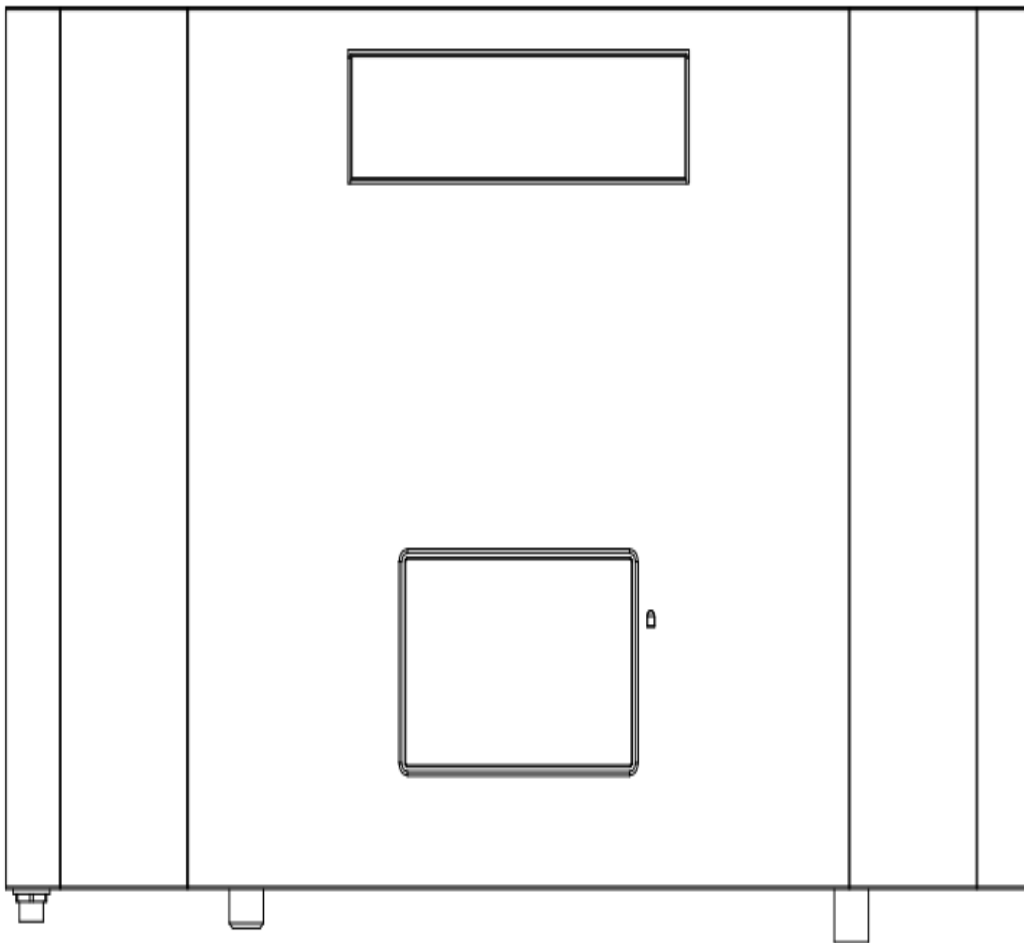

Product Description:

Wall-mounted XTREME XS ultrasonic atomization humidifier, the internal use of integrated atomization movement. Features: no mechanical drive; quiet and noiseless; high atomization

efficiency; extremely low failure rate; simple maintenance; the entire machine output of the fog particle diameter of only 1-5um; the maximum relative humidity can be up to 99% or more. Wall-mounted ultrasonic humidifier, with the exterior wall-hanging integrated design, and equipped with standard water supply inlet, water discharge outlet, etc., where the water supply inlet external tap water automatic replenishment, and **REQUIRED** Reverse Osmosis Membrane filter device for different water quality to achieve the requirements of no calcium white powder pollution. The control accuracy is within 2%.

Technical parameters:

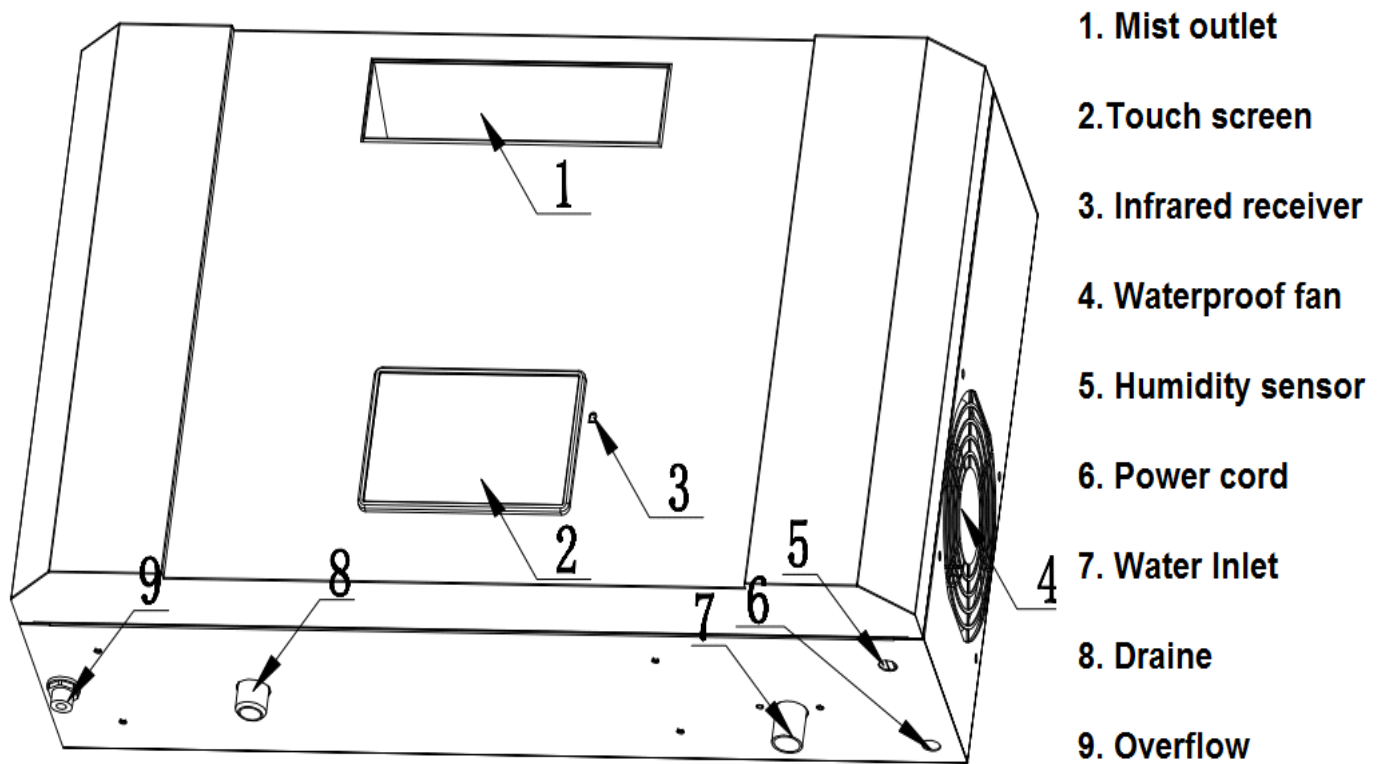

Model	XTREME XS
Mist volume	2 KG/H – .5284 GAL/H

Control method	Microcomputer auto control
Voltage	110V / 60HZ
Power	100W
Current	1 A
Display	Touch type V4.3
Operating temperature	Temperature 1-40°C Humidity \leq 85%RH
Mist outlet size	195mm*82mm
External Size	L/ 15"* W/6 1/2"* H/ 17"*
Package Size	L/20 1/2"*W/18 1/2"*H/11 1/2"
Net weight	10.8KG – 24 LBS
Gross weight	12.25KG – 27 LBS

Machine packing list.

1. 2 KG/HR wall-mounted humidifier 1PCS
2. Wall-mounted plate 1PCS
3. Water supply pipe 1PCS
4. Drainage pipe 1PCS
5. Pressure stabilization valve 1PCS
6. Remote controller 1PCS



NOW INSERT HUMIDITY SENSOR CAT PLUG AT BOTTOM OF MACHINE

Installation steps:

1. Use a horizontal ruler, hang and fixed the wall plate on the wall (typically 65" to 75" from floor)
2. Hang the machine on the wall plate
3. Install the water inlet pipe on the water inlet
- 4 Install the drainage pipe on the drain of the machine. **NOW SHUT DRAIN VALVE OFF**
5. Turn on the machine; the machine will began to feed water
6. **Turn on ... WAIT 45 seconds Turn off for 5 seconds --- REPETE 3-4 TIMES UNITL MIST APPEARS....** (this only needed at start up) once the water reach correct water level, the machine will begin misting.

Operation of the control panel

Welcome to use the wireless touch intelligent humidifier control system V4.3 developed by our company.

This control system is mainly developed for ultrasonic humidifier equipment, humidity control atomization and regular/manual operation ozone disinfection function. The equipment comes with: **humidity real-time monitoring display, temperature and humidity operating curve, 7-day data recording function**, presenting more intuitive reference data for customers. The control system provides Chinese/English switchable touch display interface, which is convenient for users to set and operate.

[Power on the device and enter the power-on interface \(customizable\)](#)

The interface displayed after power on (WE HAVE PRESET THIS FOR YOUR DATA)

Humidity and operating status are displayed during operation. Press the operation button "ON/OFF" to start and stop humidification. When the equipment is not working, **PV** refer to **PRESENT VALUE** room actual measured humidity and **SV** refer to your desired **SET VALUE** humidity. When the actual measured humidity is lower than the set humidity, the equipment starts to create mist. Under this condition, spray status display current output. When the actual measured humidity is higher than the upper limit of the set humidity, the equipment stops creating mist, and the mist output indicator light off, FAN state display "stop".

Note: If the sensor is not connected, sensor failure, the operating status will show "sensor no signal", the equipment stops running.



1. Equipment start/stop: "ON/OFF" to start/stop work.

2. Display value: PV - actual PRESENT humidity display, SV - SET humidity display.
3. Status display: FAN / ozone Generator, Green for "ON" state, Gray for "STOP" state.
4. Graph: the entrance to record the humidity operation curve.

The system will record the ambient temperature and humidity data every minute. You can click "temperature and humidity curve" to enter the temperature and humidity curve interface: click data view to see more records.

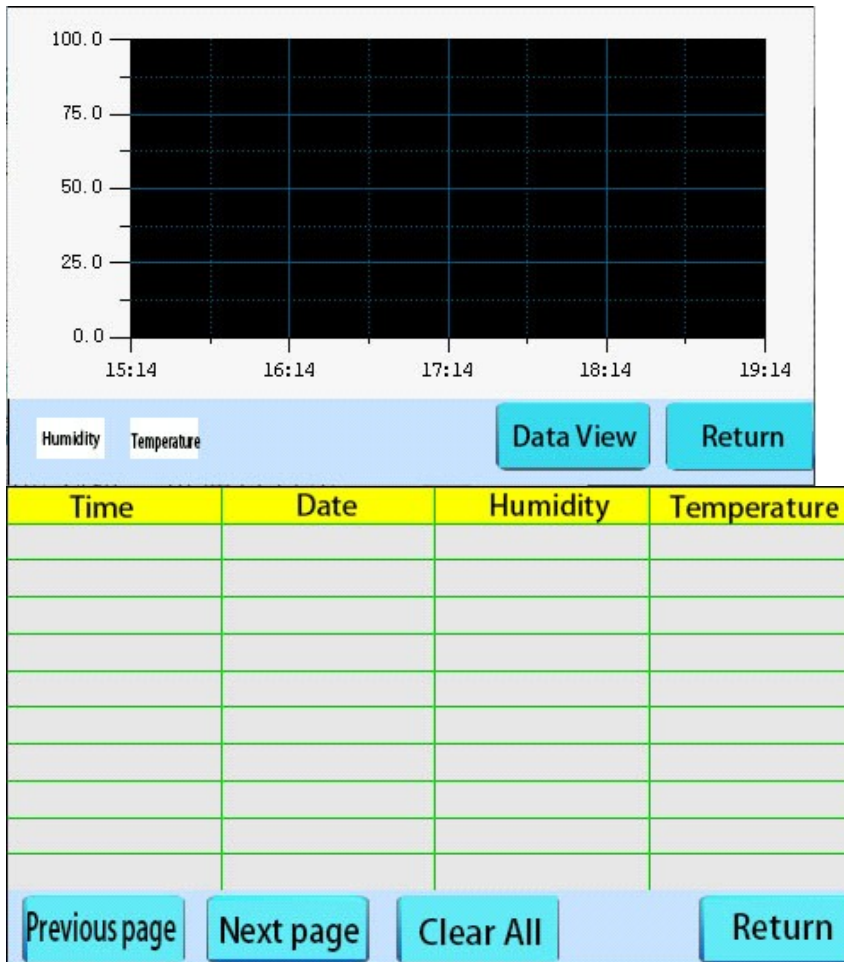

Note: Temperature and humidity data can be recorded for a maximum of 7 days (once every minute).

5. Run setting: Running parameter setting.
6. Run ozone: ozone manual mode on (run 1-99min when turn on, see "Run Parameter Setting" 1).

Run Setting

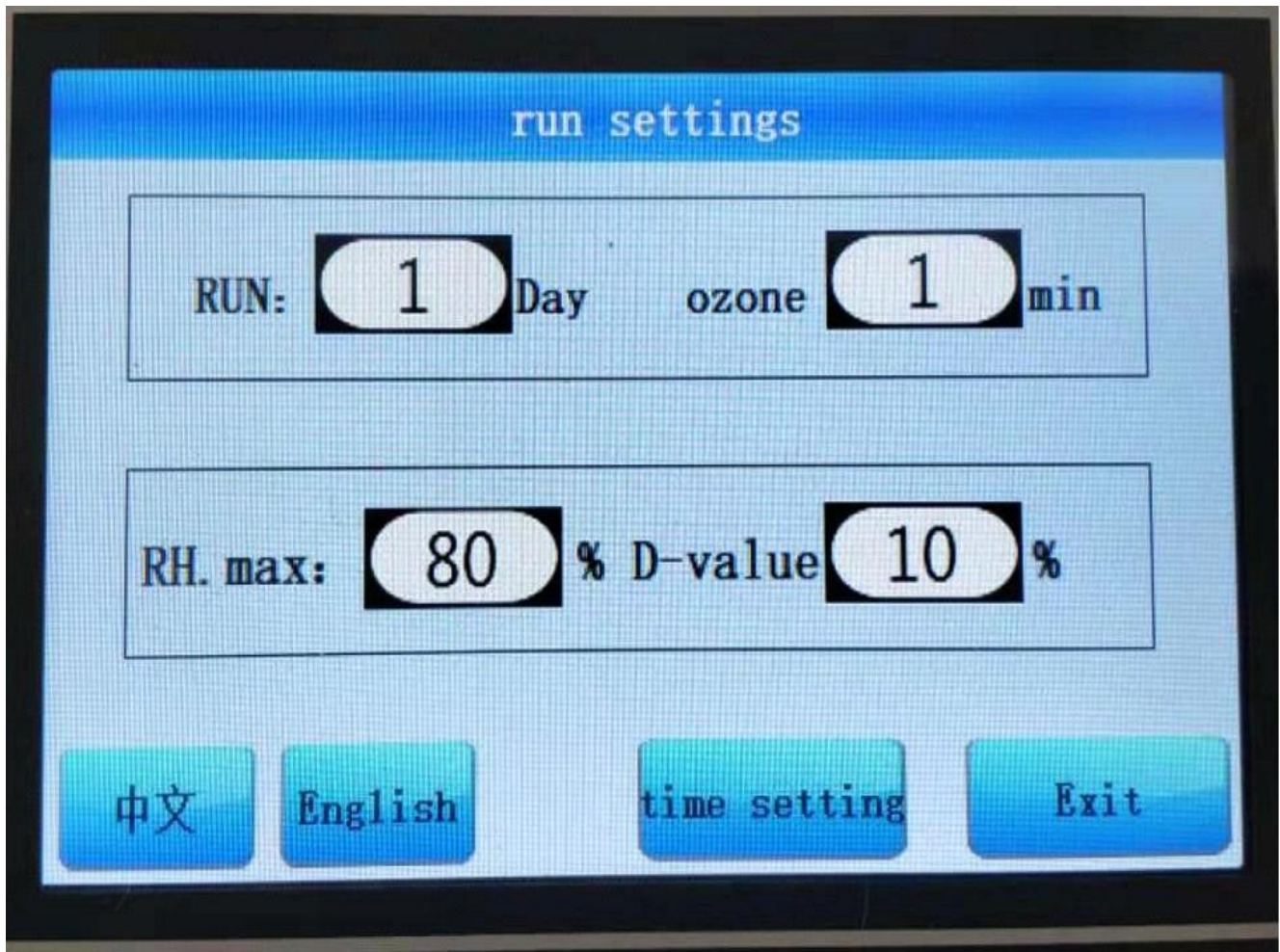

1. Ozone operation setting: RUN :(1-20)DAY ;ozone(1-99)min;

(I. Set the interval days 1-20 days II. Set time 1-99 minutes, can be manually started; Note: see "Interface Displayed after Power On " 6)

2. Humidity operation setting: RH.max (35-99)%;D-value(10-99)%;

(D-value is recommended to be less than 40%, default 5%);

- System language, Chinese/English (click to select);

4. Time setting: For system time setting;

5. Exit to save the parameters.

Time Setting

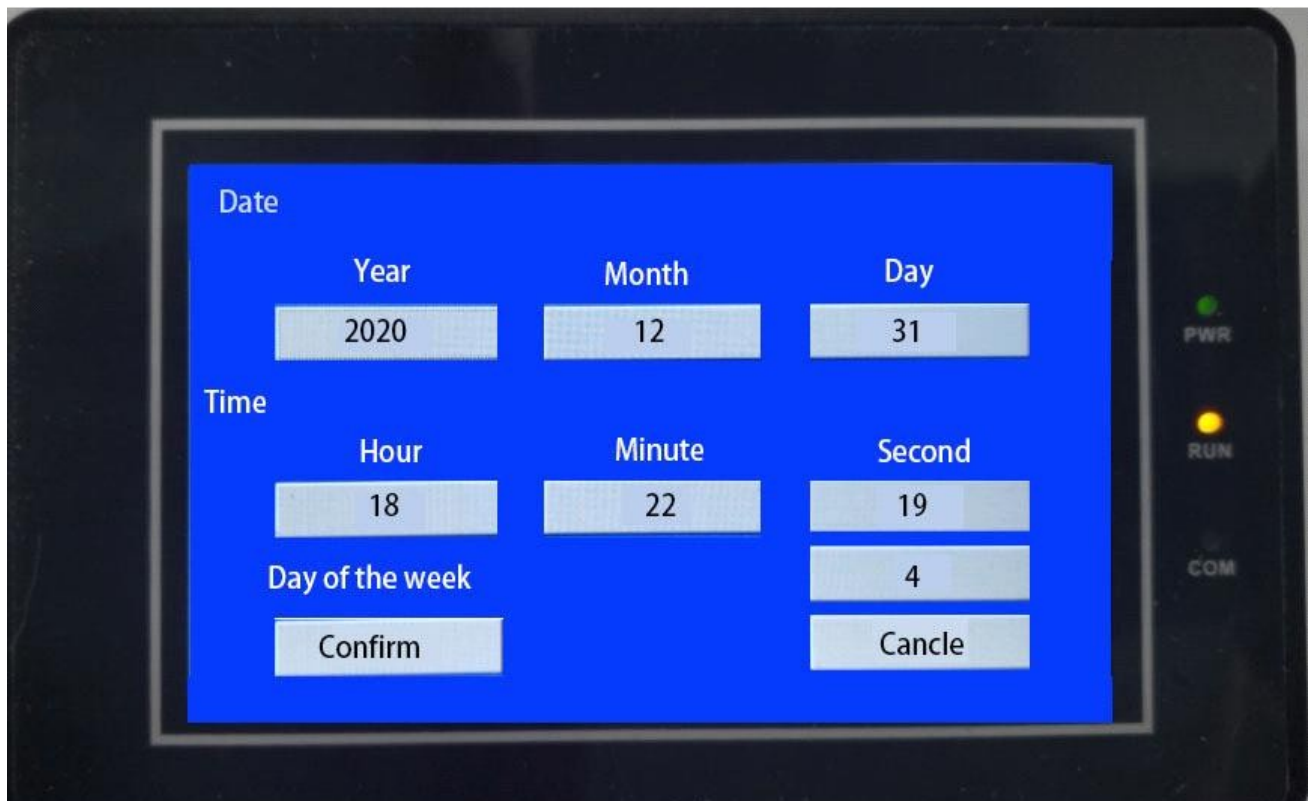

1. Date setting: Format xxxx xx xx (Example: 2021.01.01) ;
2. System time setting: format xx xx xx (example: 12.01.01);
3. Day of the Week setting: 1-7;

Note: When the setting is completed, press "OK" and the system will automatically save your setting and return to previous page.



Wireless remote control



- 1.ON/OFF
- 2.SV set "+"Add
- 3.SV set "-"Decrease

Note: 1. using battery type "CR2025" voltage "3V".

- control distance, sight distance <5m (recommended effective distance within 3m).
-

Wireless remote control @ manual operation

1.Wireless remote control can start and stop humidification by pressing the manual operation button

"". Press "" to increase SV, press "" to decrease SV.

2.The machine in manual mode will display the measured humidity and operating status. This mode requires manual operation of the equipment to start and stop spraying, press the manual operation button "ON/OFF" to start and stop humidification. The machine in manual mode will display the

measured humidity and operating status. This mode requires manual operation of the equipment to start and stop spraying, press the manual operation button "ON/OFF" to start and stop humidification. Ozone disinfection can also be turned on manually by pressing "Run Ozone".

(Wireless remote control  and manual ON/OFF, both can start and stop humidification)

Thank you again for using our products! If you have any questions, please contact TAC WATER & MISTING SYSTEMS.

Sensor technical parameters.

Humidity range: 0-99.9%

Temperature range: -40-80°C

Accuracy: Humidity $\pm 2\%$ (10-99%RH), temperature $\pm 0.4^\circ\text{C}$ (10-55°C)



Advanced Misting Systems

216 Avenida Fabricante Suite 207
San Clemente, CA 92672

760-779-1352

website: <http://www.advancedmistingystems.com>